

IMPORTANT SAFETY RULES

Read, understand, and follow all instructions carefully before installing and using this product.

Ultra Frame™ Pool

16' - 18' (488 cm - 549 cm) models



For illustrative purposes only. Accessories may not be provided with pool.

Don't forget to try these other fine Intex products: Pools, Pool Accessories, Inflatable Pools and In-Home Toys, Airbeds and Boats available at fine retailers or visit our website listed below.



©2010 Intex Marketing Ltd. - Intex Development Co. Ltd. - Intex Trading Ltd.
- Intex Recreation Corp.

All rights reserved/Tous droits réservés/Todos los derechos reservados/Alle Rechte vorbehalten. Printed in China/Imprimé en Chine/Impreso en China/Gedruckt in China.

®™ Trademarks used in some countries of the world under license from/®™ Marques utilisées dans certains pays sous licence de/Marcas registradas utilizadas en algunos países del mundo bajo licencia de/Warenzeichen verwendet in einigen Ländern der Welt in Lizenz von/Intex Marketing Ltd. to/à/a/an Intex Trading Ltd., Intex Development Co. Ltd., G.P.O. Box 28829, Hong Kong & Intex Recreation Corp., P.O. Box 1440, Long Beach, CA 90801 • Distributed in the European Union by/Distribué dans l'Union Européenne par/Distribuido en la unión Europea por/Vertrieb in der Europäischen Union durch/Intex Trading B.V., P.O. Box nr. 1075 – 4700 BB Roosendaal – The Netherlands

TABLE OF CONTENTS

Warnings..... 3

Parts List & References..... 4-5

Setup Instructions..... 6-8

Pool Maintenance and Chemicals..... 9-10

Common Pool Problems..... 9

Pool Draining..... 10

Storage..... 10-11

General Aquatic Safety..... 12

Intex Service Center Locations..... 13

Special Introductory note:

Thanks for buying an Intex pool. Please read this manual before setting up your pool. This information will help extend the pool life and make the pool safer for your family's enjoyment. View the video included before installation. A team of 2-3 people is recommended for pool set up. Additional people will speed up the installation.

IMPORTANT SAFETY RULES

Read, Understand and Follow All Instructions Carefully Before Installing and Using this Product.

WARNING

- **Continuous and competent adult supervision of children and the disabled is required at all times.**
- Secure all doors, windows and safety barriers to prevent unauthorized, unintentional or unsupervised pool entry.
- Install a safety barrier that will eliminate access to the pool for young children and pets.
- Pool and pool accessories are to be assembled and disassembled by adults only.
- Never dive, jump or slide into an above-ground pool or any shallow body of water.
- Failure to set up pool on flat, level, compact ground or over filling could result in the pool's collapse and the possibility that a person lounging in the pool could be swept out/ejected.
- Do not lean, straddle, or exert pressure on the inflatable ring or top rim as injury or flooding could occur. Do not allow anyone to sit on, climb, or straddle the sides of the pool.
- Remove all toys and flotation devices from, in and around the pool when it is not in use. Objects in the pool attract young children.
- Keep toys, chairs, tables, or any objects that a child could climb on at least four feet (1.22 meters) away from the pool.
- Keep rescue equipment by the pool and clearly post emergency numbers at the phone closest to the pool. Examples of rescue equipment: coast guard approved ring buoy with attached rope, strong rigid pole not less than twelve feet (12') [3.66m] long.
- Never swim alone or allow others to swim alone.
- Keep your pool clean and clear. The pool floor must be visible at all times from the outside barrier of the pool.
- If swimming at night use properly installed artificial lighting to illuminate all safety signs, ladders, pool floor and walkways.
- Stay away from the pool when using alcohol or drugs/medication.
- Keep children away from pool covers to avoid entanglement, drowning, or other serious injury.
- Pool covers must be completely removed before pool use. Children and adults cannot be seen under a pool cover.
- Do not cover the pool while you or anyone else is in the pool.
- Keep the pool and pool area clean and clear to avoid slips and falls and objects that may cause injury.
- Protect all pool occupants from recreational water illnesses by keeping the pool water sanitized. Don't swallow the pool water. Practice good hygiene.
- All pools are subject to wear and deterioration. Certain types of excessive or accelerated deterioration can lead to an operation failure, and can ultimately cause the loss of large quantities of water from your pool. Therefore, it is very important that you properly maintain your pool on a regular basis.
- This pool is for outdoor use only.
- Empty and store the pool when not in use for a longer period. See storage instructions.
- While the swimming pool is in use, you will need to operate the filter pump to ensure that there is at least one complete change of water a day. Consult your pump's manual to calculate the necessary operating hours.









POOL BARRIERS AND COVERS ARE NOT SUBSTITUTES FOR CONTINUOUS AND COMPETENT ADULT SUPERVISION. POOL DOES NOT COME WITH A LIFEGUARD. ADULTS ARE THEREFORE REQUIRED TO ACT AS LIFEGUARDS OR WATER WATCHERS AND PROTECT THE LIVES OF ALL POOL USERS, ESPECIALLY CHILDREN, IN AND AROUND THE POOL.

FAILURE TO FOLLOW THESE WARNINGS MAY RESULT IN PROPERTY DAMAGE, SERIOUS INJURY OR DEATH.

Advisory:

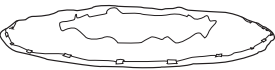
Pool owners may need to comply with local or state laws relating to childproof fencing, safety barriers, lighting, and other safety requirements. Customers should contact their local building code enforcement office for further details.

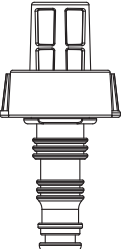
PARTS LIST

<p>1</p> 	<p>2</p> 	<p>3</p> 
<p>4</p> 	<p>5</p> 	<p>6</p> 
<p>7</p> 	<p>8</p> 	<p>9</p> 
<p>10</p> 		

NOTE: Drawings for illustration purpose only. Actual product may vary. Not to scale.

PARTS LIST

PARTS REFERENCE

Before assembling your product, please take a few minutes to check the contents and become familiar with all the parts.

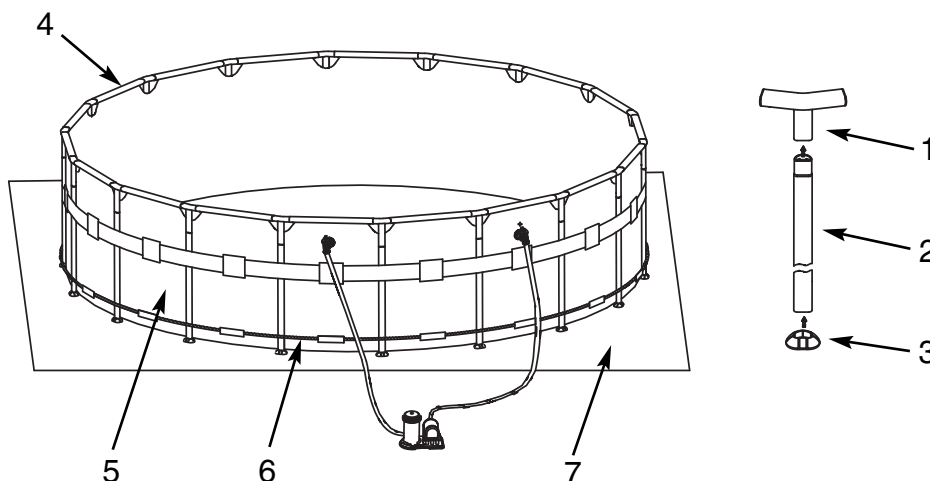

NOTE: Drawings for illustration purpose only. Actual product may vary. Not to scale.

16' (488 cm) & 18' (549 cm) models

REF NO.	DESCRIPTION	POOL SIZE & QUANTITIES	
		16' (488cm)	18' (549cm)
1	T - JOINT	16	18
2	VERTICAL LEG	16	18
3	LEG CAP	16	18
4	HORIZONTAL BEAM	16	18
5	POOL LINER (DRAIN VALVE CAP INCLUDED)	1	1
6	RESTRAINING ROPE	1	1
7	GROUND CLOTH	1	1
8	DRAIN CONNECTOR	1	1
9	DRAIN VALVE CAP	1	2
10	POOL COVER	1	1

REF NO.	DESCRIPTION	16' x 48" (488cm x 122cm)	18' x 52" (549cm x 132cm)
		SPARE PART NO.	
1	T - JOINT	10982	10983
2	VERTICAL LEG	10981	10981
3	LEG CAP	10984	10984
4	HORIZONTAL BEAM	10980	10980
5	POOL LINER (DRAIN VALVE CAP INCLUDED)	11080	10989
6	RESTRAINING ROPE	10317	10317
7	GROUND CLOTH	18927	18933
8	DRAIN CONNECTOR	10201	10201
9	DRAIN VALVE CAP	11044	11044
10	POOL COVER	10754	18937

PARTS REFERENCE

POOL SETUP

IMPORTANT SITE SELECTION AND GROUND PREPARATION INFORMATION

⚠ WARNING

- The pool location must allow you to secure all doors, windows, and safety barriers to prevent unauthorized, unintentional or unsupervised pool entry.
- Install a safety barrier that will eliminate access to the pool for young children and pets.
- Failure to set up the pool on flat, level, compact ground and to assemble, and fill with water in accordance with the following instructions could result in the pool's collapse or the possibility that a person lounging in the pool could be swept out/ejected, resulting in serious injury or property damage.
- Risk of electric shock: connect the filter pump only to a grounding type receptacle protected by a ground-fault circuit interrupter (GFCI) or residual current device (RCD). To reduce the risk of an electrical shock, do not use extension cords, timers, plug adapters or converter plugs to connect the pump to an electrical supply. Always provide a properly located outlet. Locate the cord where it cannot be damaged by lawn mowers, hedge trimmers, and other equipment. See the filter pump manual for additional warnings and instructions.

Select an outdoor location for the pool with the following requirements in mind:

1. The area where the pool is to be set up must be **absolutely flat and level**.
Do not set up the pool on a slope or inclined surface.
2. The ground surface must be compacted and firm enough to withstand the pressure and weight of a fully set up pool. **Do Not** set up the pool on mud, sand, soft or loose soil conditions.
3. **Do Not** set up the pool on a deck, balcony or platform.
4. The pool requires at least 4 feet of space all around pool from objects that a child could climb on to gain access to the pool.
5. The chlorinated poolwater could damage the surrounding vegetation. Certain types of grass such as St. Augustine and Bermuda, may grow through the liner. Grass growing through the liner it is not a manufacture defect and is not covered under warranty.

POOL SETUP (continued)

You may have purchased this pool with the Intex Krystal Clear™ filter pump. The pump has its own separate set of installation instructions. First assemble your pool unit and then set up the filter pump.

Estimated assembly time 45~60 minutes. (Note the assembly time is only approximate and individual assembly experience may vary.)

1. Liner preparation

- Find a flat, level location that is free and clear of stones, branches or other sharp objects that may puncture the pool liner or cause injury.
- Open the carton containing the liner, joints, legs, etc., very carefully as this carton can be used to store the pool during the winter months or when not in use.

- Take out the ground cloth (7) and spread it over the cleared area. Then, take out the liner (5) and spread it out over the ground cloth, with the drain valve directed towards the draining area. Place the drain valve away from the house. Allow the sun to warm up the liner before inserting the beams (4) into the sleeve openings.

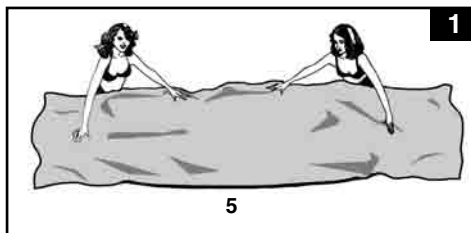

IMPORTANT: Always set up the pool unit with at least 2 persons. Do not drag the liner across the ground as this can cause liner damage and pool leakage (see drawing 1).

- During the setup of the pool liner, point the hose connections or openings in the direction of the electrical power source. The outer edge of the pool should be within reach of the pump's electrical connection.

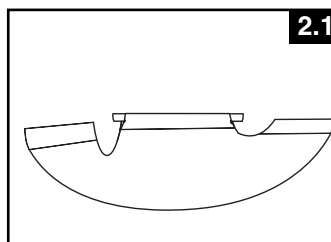

2. Frame assembly

- The frame pool's legs (2) and beams (4) fall into two groups. The smaller diameters are the vertical legs. Both these legs and beams fit into the T-joints (1).
- Starting at any location, but always working in the same direction, push the horizontal beam into the sleeve (see drawing 2.1). Once the beam is centered take one of the T-joints (1), snap the joint to one end of the beam by aligning the hole and the spring-loaded pin. Repeat this procedure in a circular fashion until all the beams and joints have been connected (see drawing 2.2).

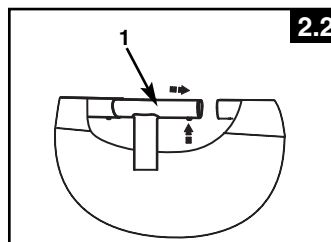

The last joint connection may be difficult to complete, but can be easily done by simultaneously raising this last joint and beam about 2 inches (5 cm), and connect the beam to the joint while lowering these pieces to their normal position. The joint will slide into the beam (see drawing 2.3). Make sure the last joint is fully assembled before proceeding to assembling the legs.

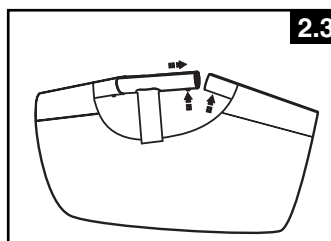

POOL SETUP (continued)

- Next slide the vertical legs into the belt loop located in the middle of the pool liner. The bottom of the leg should be inside the white restraining rope (6) located near the liner's bottom edge. Carefully slide the leg into the belt loop and place the leg's bottom inside the rope and then insert the top of the leg into the bottom of the joint. Snap the leg into joint's holes by aligning the hole and the spring-loaded pin. Attach the leg's end cap (3) to the bottom of the leg (see drawing 3).

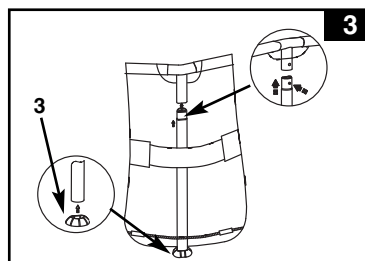

- Grab the frame pool's top beams in 2 – 3 locations and "shake" the pool to be sure all the joints, legs and beams "fit into each other".
- Pull gently, in an outward direction, the bottom of the leg; making sure the leg is inside the restraining rope.
- **If pool was purchased with a filter pump, read the Krystal Clear™ Filter Pump Manual first and then proceed to next installation step.**

3. Filling of the pool

- Before filling the pool with water, ensure that the drain plug inside the pool is closed and that the drain cap on the outside is screwed on tightly. Fill the pool with no more than 1 inch (2.5 cm) of water. Check to see whether the water is level.
IMPORTANT: If the water in the pool flows to one side, the pool is not completely level. Setting up the pool on unlevel ground will cause the pool to tilt resulting in the sidewall material bulging and a potential collapse of the pool. If the pool is not completely level, you must drain the pool, level the area or move the pool to a different area that is level, and re-fill the pool, following the above directions.
- Smooth out the bottom liner wrinkles (from inside the pool) by pushing out where the pool floor and pool sides meet. Or, (from outside pool) reach under the side of the pool, grasp the pool floor and pull in an outward direction. If the ground cloth is causing the wrinkles, have 2 adults pull from opposite sides to remove all wrinkles. Use the properly assembled pool ladder when entering or exiting the pool during this process.

- 4. Fill the pool with water up to just below the sleeve line (see drawing 4).

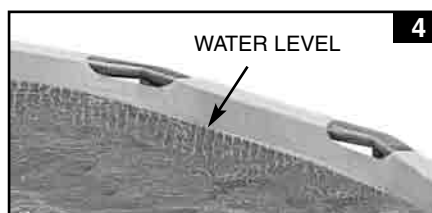

IMPORTANT

Before allowing anyone to use the pool, hold a family meeting. Establish a set of rules that include, at a minimum, the important safety rules and general aquatic safety information in this manual. Review these rules on a regular basis and with all users of the pool, including guests.

POOL MAINTENANCE & CHEMICALS

WARNING

REMEMBER TO

- Protect all pool occupants from possible water-related illnesses by keeping the pool water clean and sanitized. Do not swallow the pool water. Always practice good hygiene.
- Keep your pool clean and clear. The pool floor must be visible at all times from the outside barrier of the pool.
- Keep children away from pool covers to avoid entanglement, drowning, or other serious injury.

Water maintenance

The maintenance of a proper water balance through appropriate use of sanitizers is the single most important factor in maximizing the life and appearance of the liner as well as ensuring clean, healthy and safe water. Proper technique is important for water testing and treating the pool water. See your pool professional for chemical, test kits and testing procedures. Be sure to read and follow the written instructions from the chemical manufacturer.

1. Never let chlorine come into contact with the liner if it is not completely dissolved. Dissolve granular or tablet chlorine first in a bucket of water, then add it to the pool water. Likewise with liquid chlorine; mix it immediately and thoroughly with the pool water.
2. Never mix chemicals together. Add chemicals to the pool water separately. Thoroughly dissolve each chemical before adding another one to the water.
3. An Intex pool skimmer and an Intex pool vacuum are available to assist in maintaining clean pool water. See your pool dealer for these pool accessories.
4. Do not use a pressure washer to clean the pool.

TROUBLESHOOTING

PROBLEM	DESCRIPTION	CAUSE	SOLUTION
ALGAE	<ul style="list-style-type: none"> • Greenish water. • Green or black spots on pool liner. • Pool liner is slippery and/or has a bad odor. 	<ul style="list-style-type: none"> • Chlorine and pH level need adjustment. 	<ul style="list-style-type: none"> • Super chlorinate with shock treatment. Correct pH to your pool store's recommended level. • Vacuum pool bottom. • Maintain proper chlorine level.
COLORED WATER	<ul style="list-style-type: none"> • Water turns blue, brown, or black when first treated with chlorine. 	<ul style="list-style-type: none"> • Copper, iron or manganese in water being oxidized by the added chlorine. 	<ul style="list-style-type: none"> • Adjust pH to recommended level. • Run filter until water is clear. • Replace cartridge frequently.
FLOATING MATTER IN WATER	<ul style="list-style-type: none"> • Water is cloudy or milky. 	<ul style="list-style-type: none"> • "Hard water" caused by a too high pH level. • Chlorine content is low. • Foreign matter in water. 	<ul style="list-style-type: none"> • Correct the pH level. Check with your pool dealer for advice. • Check for proper chlorine level. • Clean or replace your filter cartridge.
CHRONIC LOW WATER LEVEL	<ul style="list-style-type: none"> • Level is lower than on previous day. 	<ul style="list-style-type: none"> • Rip or hole in pool liner or hoses. 	<ul style="list-style-type: none"> • Repair with patch kit. • Finger tighten all caps. • Replace the hoses.
SEDIMENT ON POOL BOTTOM	<ul style="list-style-type: none"> • Dirt or sand on pool floor. 	<ul style="list-style-type: none"> • Heavy use, getting in and out of pool. 	<ul style="list-style-type: none"> • Use Intex pool vacuum to clean bottom of pool.
SURFACE DEBRIS	<ul style="list-style-type: none"> • Leaves, insects etc. 	<ul style="list-style-type: none"> • Pool too close to trees. 	<ul style="list-style-type: none"> • Use Intex pool skimmer.

POOL MAINTENANCE & DRAINAGE

⚠ CAUTION

ALWAYS FOLLOW THE CHEMICAL MANUFACTURER'S DIRECTIONS, AND THE HEALTH AND HAZARD WARNINGS.

Do not add chemicals if the pool is occupied. This can cause skin or eye irritation.

Concentrated chlorine solutions can damage the pool liner. In no event is Intex Recreation Corp., Intex Development Co. Ltd., their related companies, authorized agents and service centers, retailers or employees liable to the buyer or any other party for the costs associated with the loss of pool water, chemicals or water damage. **Keep spare filter cartridges on hand. Replace cartridges every two weeks.** We recommend the use of a Krystal Clear™ Intex Filter Pump with all of our above-ground-pools.

EXCESSIVE RAIN: To avoid damage to the pool and over filling, immediately drain rain water that causes the water level to be higher than the maximum.

How to Drain Your Pool and Long Term Storage

1. Check local regulations for specific directions regarding disposal of swimming pool water.
2. Check to make sure that the drain plug inside the pool is plugged in place.
3. Remove the cap from the drain valve on the outside pool wall.
4. Attach the female end of the garden hose to the drain connector (8).
5. Place the other end of the hose in an area where the water can be safely drained away from the house and other nearby structures.
6. Attach the drain connector to the drain valve. **NOTE: The drain connector will push the drain plug open inside the pool and water will start to drain immediately.**
7. When the water stops draining, start lifting the pool from the side opposite the drain, leading any remaining water to the drain and emptying the pool completely.
8. Disconnect hose and adapter when finished.
9. Re-insert drain plug in drain valve on inside of pool for storage.
10. Replace drain cap on outside of pool.
11. Reverse set up instructions to disassemble the pool, and remove all connecting parts.
12. Be sure that the pool and all parts are completely dry before storage. Air dry the liner in the sun for an hour before folding (see drawing 5). Sprinkle some talcum powder to prevent the vinyl from sticking together and to absorb any residual moisture.
13. Create a square shape. Starting at one side, fold one-sixth of liner in on itself twice. Do the same on the opposite side (see drawings 6.1 & 6.2).
14. Once you have created two opposing folded sides, simply fold one over the other like closing a book (see drawings 7.1 & 7.2).
15. Fold the two long ends to the middle (see drawing 8).
16. Fold one over the other like closing a book and finally compact the liner (see drawing 9).
17. Store the liner and accessories in a dry, temperature controlled, between 32 degrees Fahrenheit (0 degrees Celsius) and 104 degrees Fahrenheit (40 degrees Celsius), storage location.
18. The original packing can be used for storage.

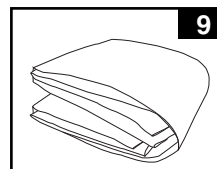
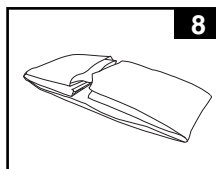
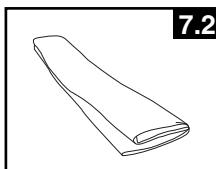
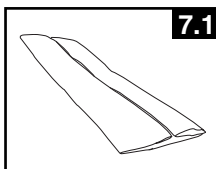
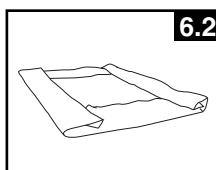
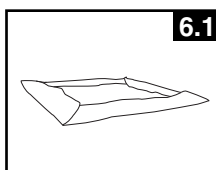
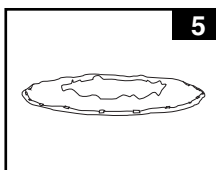

STORAGE

WINTER PREPARATIONS

Winterizing your Above Ground Pool

After usage, you can easily empty and store away your pool in a safe place. Some pool owners, however, choose to leave their pool up all year round. In cold areas, where freezing temperatures occur, there can be a risk of ice damage to your pool. We therefore recommend you drain, disassemble and properly store the pool, when the temperature drops below 32 degrees Fahrenheit (0 degrees Celsius). Also see the section "How To Drain Your Pool".

Should you choose to leave your pool out, prepare it as follows:

1. Clean the pool water thoroughly. (If the type is an Easy Set Pool or an Oval Frame Pool, make sure that the top ring is properly inflated).
2. Remove the skimmer (if applicable) or any accessories attached to the threaded strainer connector. Replace strainer grid if necessary. Be sure all accessories parts are clean and completely dry before storage.
3. Close the Inlet and Outlet Plunger Valve.
4. Remove the ladder (if applicable) and store in a safe place. Be sure the ladder is completely dry before storage.
5. Remove the hoses that connect the pump and filter to the pool.
6. Add the appropriate chemicals for the winter period. Consult your local pool dealer as to which chemicals you should use and how to use them. This can vary greatly by region.
7. Cover pool with Intex Pool Cover. **IMPORTANT NOTE: INTEX POOL COVER IS NOT A SAFETY COVER.**
8. Clean and drain the pump, filter housing and hoses. Remove and discard the old filter cartridge. Keep a spare cartridge for the next season).
9. Bring pump and filter parts indoors and store in a safe and dry area, preferably between 32 degrees Fahrenheit (0 degrees Celsius) and 104 degrees Fahrenheit (40 degrees Celsius).

STORAGE

GENERAL AQUATIC SAFETY

Water recreation is both fun and therapeutic. However, it involves inherent risks of injury and death. To reduce your risk of injury, read and follow all product, package and package insert warnings and instructions. Remember, however, that product warnings, instructions and safety guidelines cover some common risks of water recreation, but do not cover all risks and dangers.

For additional safeguards, also familiarize yourself with the following general guidelines as well as guidelines provided by nationally recognized Safety Organizations:

- Demand constant supervision. A competent adult should be appointed as a "lifeguard" or water watcher, especially when children are in and around the pool.
- Learn to swim.
- Take the time to learn CPR and first aid.
- Instruct anyone who is supervising pool users about potential pool hazards and about the use of protective devices such as locked doors, barriers, etc.
- Instruct all pool users, including children what to do in case of an emergency.
- Always use common sense and good judgement when enjoying any water activity.
- Supervise, supervise, supervise.

For service questions or to order replacement parts, please contact the appropriate office listed below or visit www.intexdevelopment.com for answers to most frequently asked questions.

AREAS	LOCATION	AREAS	LOCATION
• ASIA	INTEX DEVELOPMENT CO. LTD. 9TH FLOOR, DAH SING FINANCIAL CENTRE, 108 GLOUCESTER ROAD, WANCHAI, HONG KONG TEL: 852-28270000 FAX: 852-23118200 E-mail: xmservicesupport@intexcorp.com.cn Website: www.intexdevelopment.com	• ARGENTINA	JARSE INDUSTRIAL Y COMERCIAL S.A MANUEL GARCIA N°124, PARQUE PATRICO, BUENOS AIRES, ARGENTINA TEL: 4942-2238 (interno 106); TEL: 4942-2238 (interno 145) E-mail: Martin.Cosoletto@jarse.com.ar E-mail: Daniel.Centurion@jarse.com.ar Website: www.jarse.com.ar
• EUROPE	INTEX TRADING B.V. POSTBUS 1075, 4700 BB ROOSENDAAL, THE NETHERLANDS TEL: 31-(0)165-593939 FAX: 31-(0)165-593969 E-mail: service@intexcorp.nl Website: www.intexcorp.nl	• PERU	COMEXA S.A. AVENIDA COMANDANTE ESPINAR 142, MIRAFLORES, LIMA, PERU TEL: 446-9014
• FRANCE	UNITEX INTEX SERVICE FRANCE S.A.S 52, ROUTE NATIONALE, 39190 BEAUFORT, FRANCE TEL: 08 90 71 20 39 (0,15€/min) FAX: 03 84 25 18 09 Website: www.intex.fr	• SAUDI ARABIA	SAUDI ARABIAN MARKETING & AGENCIES CO. LTD. PRINCE AMIR MAJED STREET, AL-SAFA DISTRICT, JEDDAH, KINGDOM OF SAUDI ARABIA TEL: 966-2-693 8496 FAX: 966-2-271 4084 E-mail: toy@samaco.com.sa Website: www.samaco.com.sa
• GERMANY	STEINBACH VERTRIEBSGMBH C/O WEBOPAC LOGISTICS GMBH INTER-LOGISTIK-PARK 1-3 87600 KAUFBEUREN TEL: 0180 5 405 100 200 (0,14€/min aus dem Festnetz, Mobilfunk max. 0,42€/min) FAX: + 43 (7262) 61439 E-mail: service@intexcorp.de Website: www.intexcorp.de	• AUSTRIA	STEINBACH VERTRIEBSGMBH AISTINGERSTRASSE 2 4311 SCHWERTBERG TEL: 0820 - 200 100 200 (0,145€/min aus allen Netzen) FAX: + 43 (7262) 61439 E-mail: service@intexcorp.at Website: www.intexcorp.at
• ITALY	A & A MARKETING SERVICE VIA RAFFAELLO SANZIO 20058 VILLASANTA (MI) TEL: 199 12 19 78 FAX: +39 039 2058204 E-mail: info@intexitalia.com Website: www.intexitalia.com	• CZECH REPUBLIC / EASTERN EUROPE	INTEX TRADING S.R.O. BENEŠOVSKA 23, 101 00 PRAHA 10, CZECH REPUBLIC TEL: +420-267 313 188 FAX: +420-267 312 552 E-mail: info@intexcorp.cz
• UK	TOY BROKERS LTD MARKETING HOUSE, BLACKSTONE ROAD, HUNTINGDON, CAMBS. PE29 6EF, UK TEL: 0844 561 7129 FAX: 01480 414761 E-mail: sales@toybrokers.com Website: www.intexspares.com	• BELGIUM	N.V. SIMBA-DICKIE BELGIUM S.A. MOESKROENSTEELENWEG 383C, 8511 AALBEKE, BELGIUM TEL: 0800 92088 FAX: 32-56.26.05.38 E-mail: intex@nicotoy.be E-mail: intexsupport@nicotoy.be Website: www.nicotoy.be/downloads.htm
• SWITZERLAND	GWM AGENCY GARTEN-U. WOHNMÖBEL, RÄFFELSTRASSE 25, POSTFACH, CH-8045 ZÜRICH/SWITZERLAND TEL: 0900 455456 or +41 44 455 50 60 FAX: +41 44 455 50 65 E-mail: gwm@gwm.ch Website: www.gwm.ch , www.gwmsale.ch	• DENMARK	K.E. MATHIASSEN A/S SINTRUPVEJ 12, DK-8220 BRABRAND, DENMARK TEL: +45 89 44 22 00 FAX: +45 86 24 02 39 E-mail: intex@keleg.dk Website: www.intexnordic.com
• SPAIN / PORTUGAL	Nostrum Iberian Market S.A. Av. de la Albufera, 321 28031 Madrid, Spain TEL: +34 902101339 FAX for Spain: +34 9 029 089 76 Email for Spain: sat@intexiberian.com FAX for Portugal: +351 707 506 090 Email for Portugal: spv-pt@intexiberian.com Website: www.intexiberian.com	• SWEDEN	LEKSAM AB BRANDSVIGSGATAN 6, S-262 73 ÄNGELHOLM, SWEDEN TEL: +46 431 44 41 00 FAX: +46 431 190 35 E-mail: intex@leksam.se Website: www.intexnordic.com
• AUSTRALIA	HUNTER PRODUCTS PTY LTD LEVEL 1, 225 BAY STREET, BRIGHTON, VICTORIA, AUSTRALIA TEL: 61-3-9596-2144 or 1800-224-094 FAX: 61-3-9596-2188 E-mail: Enquiries@hunteroverseas.com.au Website: www.hunterproducts.com.au	• NORWAY	PINDSLEVEIEN 1, N-3221 SANDEFJORD, NORWAY TEL: +47 33 48 74 10 FAX: +47 33 48 74 11 E-mail: intex@norstar.no Website: www.intexnordic.com
• NEW ZEALAND	HAKA NEW ZEALAND LIMITED UNIT 4, 11 ORBIT DIVE, ALBANY, AUCKLAND 0757, NEW ZEALAND TEL: 649-4159213 / 0800 634434 FAX: 649-4159212 E-mail: geoff@hakanz.co.nz Website: www.hakanz.co.nz	• FINLAND	NORSTAR OY SUOMALAISTENTIE 7, FIN-02270 ESPOO, FINLAND TEL: +358 9 8190 530 FAX: +358 9 8190 5335 E-mail: info@norstar.fi Website: www.intexnordic.com
• MIDDLE EAST REGION	FIRST GROUP INTERNATIONAL AL MOOSA GROUP BUILDING, 1ST FLOOR, OFFICE 102 & 103, UMM HURAIR ROAD, KARAMA, DUBAI, UAE TEL: 00971-4-8001NTEX(46839) / +971-4-3373322 FAX: 00971-4-3375115 E-mail: intex@firstgroupinternational.com Website: www.firstgroupinternational.com	• RUSSIA	LLC BAUER KIEVSKAYA STR., 20, 121165 MOSCOW, RUSSIA TEL: 099-249-9400/8626/9802 FAX: 095-742-8192 E-mail: intex.russia@gmail.com Website: www.intex.ru
• SOUTH AFRICA	WOOD & HYDE 15-17 PACKER AVENUE, INDUSTRIA 2, CAPE TOWN, SOUTH AFRICA 7460 TEL: 27-21-0800-204-692 FAX: 27-21-505-5600 E-mail: ygoldman@melbro.co.za	• POLAND	KATHAY HASTER UL. LUTYCKA 3, 60-415 POZNAN TEL: +48 61 8498 334 FAX: +48 61 8474 487 E-mail: inx@kathay.com.pl Website: www.intexpoland.pl
• CHILE / URUGUAY	COMEXA S.A. EL JUNCAL 100, PARQUE INDUSTRIAL PORTEZUELO, QUILICURA, SANTIAGO, CHILE. TEL: 600-822-0700 E-mail: serviciotecnico@silfa.cl	• HUNGARY	RECONTRA LTD./RICKI LTD. H-1113 BUDAPEST, DARÓCZI ÚT 1-3, HUNGARY TEL: +361 372 5200/113 FAX: +361 209 2634 E-mail: service@recontra.hu
		• BRASIL	KONESUL MARKETING & SALES LTDA RUA ANTONIO DAS CHAGAS, 1.528 - CEP. 04714-002, CHACARA SANTO ANTONIO - SÃO PAULO - SP - BRASIL TEL: 55 (11) 5181 4646 FAX: 55 (11) 5181 4646 E-mail: sacintexbrasil@uol.com.br
		• ISRAEL	ALFIT TOYS LTD MOSHAV NEHALIM, MESHEK 32, 49950, ISRAEL TEL: +972-3-9076666 FAX: +972-3-9076660 E-mail: michald@chagim.co.il